



NYLON FUEL LINE REPAIR KIT

800-300 INSTRUCTION SHEET

CAUTION!

Gasoline is very flammable. Fuel systems can be under pressure. Drain system per manufacturer's procedures. Use caution to avoid contact. Do not smoke or expose fuel system to extreme heat or open flame. Upon completion, inspect all fuel system repairs for leaks.

TECH TIP Some connectors, particularly those with tall barbs may be difficult to install. Applying a thin film of motor oil to the connector barbs before attachment will greatly reduce the force needed.

¡ADVERTENCIA!

La gasolina es muy inflamable. Los sistemas de combustible pueden estar bajo presión. Drene el sistema siguiendo las instrucciones del fabricante. Tenga cuidado para evitar el contacto. No fume o exponga el sistema de combustible al calor extremo o a las llamas. Cuando termine, revise todo el sistema de combustible para verificar que no tenga pérdidas.

CONSEJO TÉCNICO Algunos conectores, particularmente aquellos con molduras altas, pueden ser difíciles de instalar. El colocar una película delgada de aceite del motor en la moldura del conector antes de instalarlo reducirá la fuerza necesaria.

ATTENTION!

L'essence est très inflammable. Les circuits d'alimentation peuvent être sous pression. Système de vidange selon les méthodes du fabricant. Soyez prudent afin d'éviter tout contact. Ne fumez pas ou n'exposez pas le circuit d'alimentation à une chaleur extrême ou à une flamme nue. Après avoir terminé, vérifiez la présence de fuites dans toutes les réparations du circuit d'alimentation.

CONSEIL TECHNIQUE Certains connecteurs, surtout ceux à grandes barbelures peuvent être difficiles à installer. L'application d'une mince couche d'huile à moteur aux barbelures du connecteur avant de le fixer réduira considérablement la force demandée.

Technical Support 1-800-336-3575

Parts

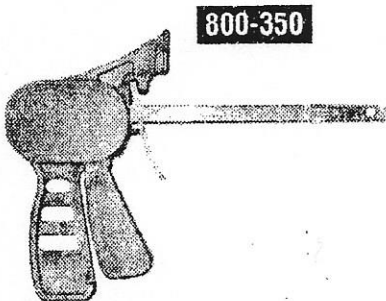

800-350



800-353



800-355

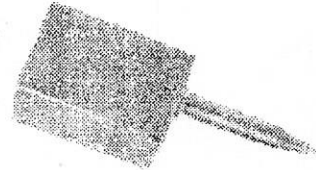

800-351

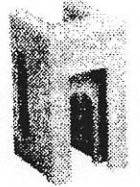

800-356

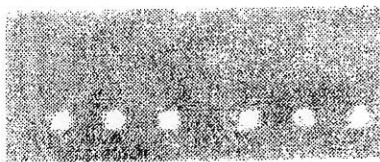

800-352



800-354

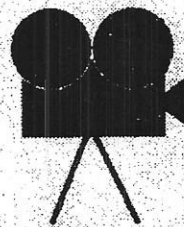

www.DormanProducts.com/video

Straight Fittings

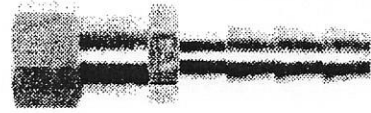
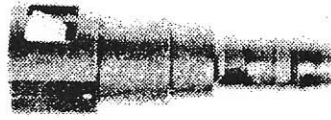

1

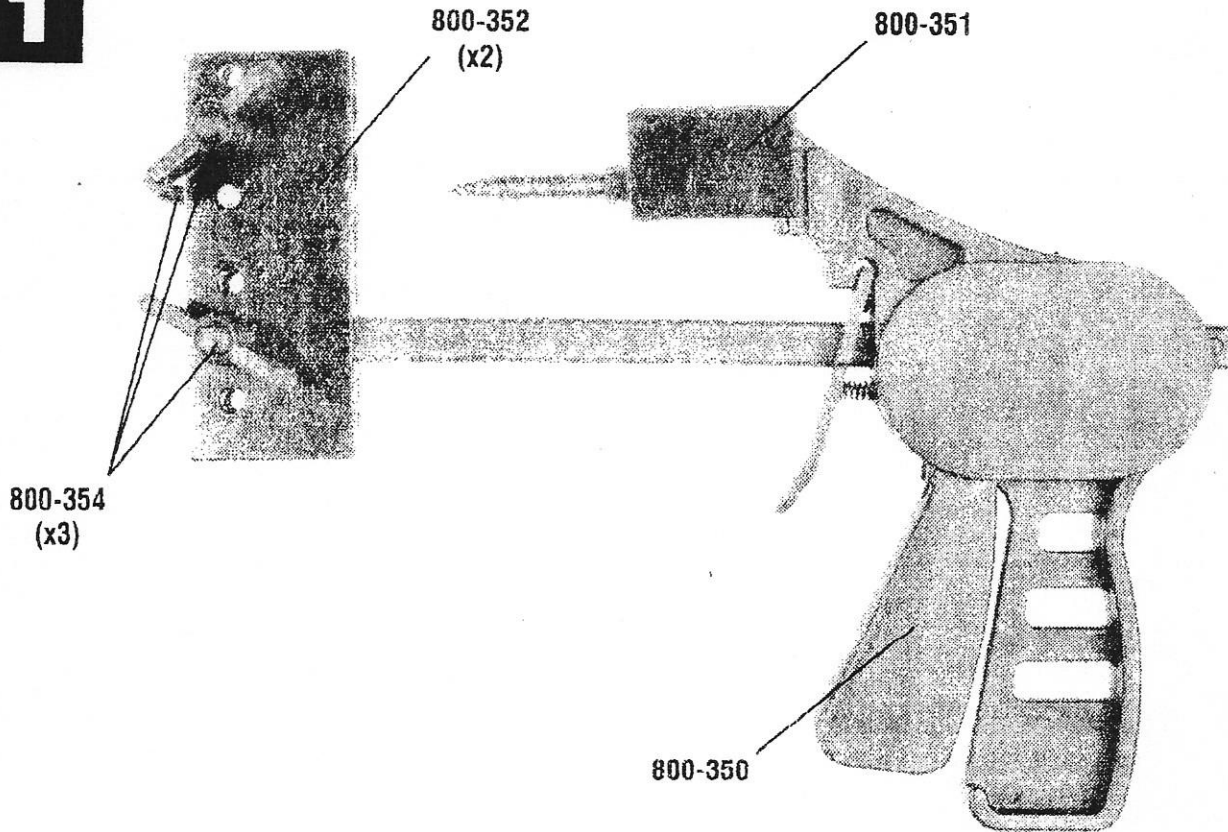

2

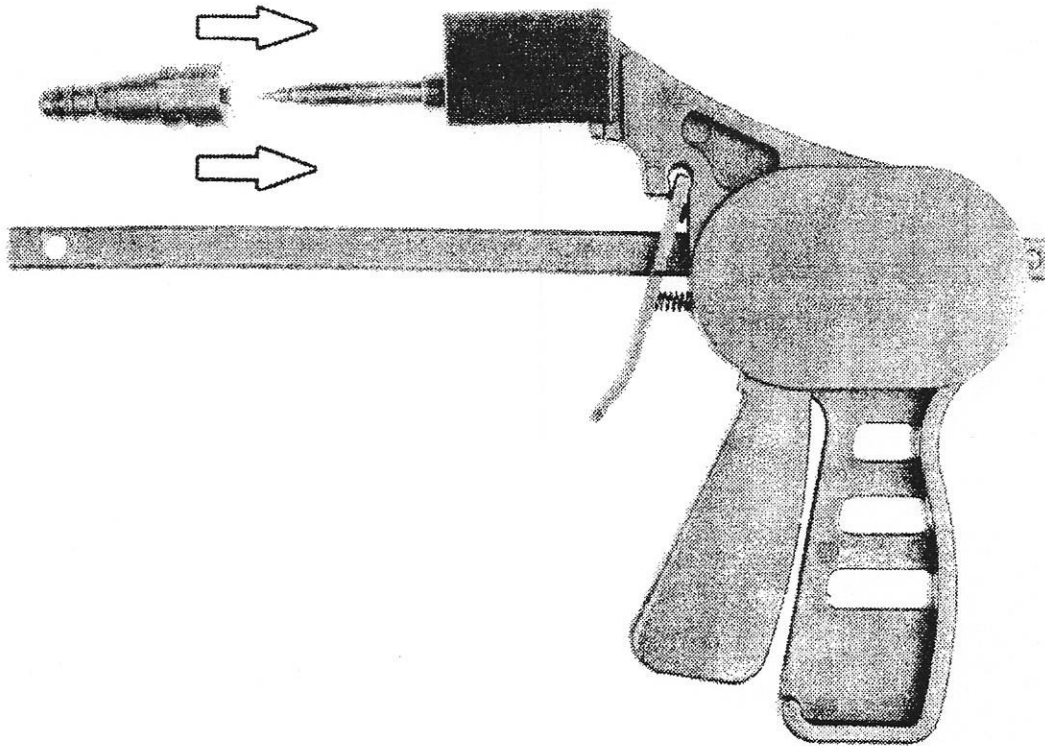

3

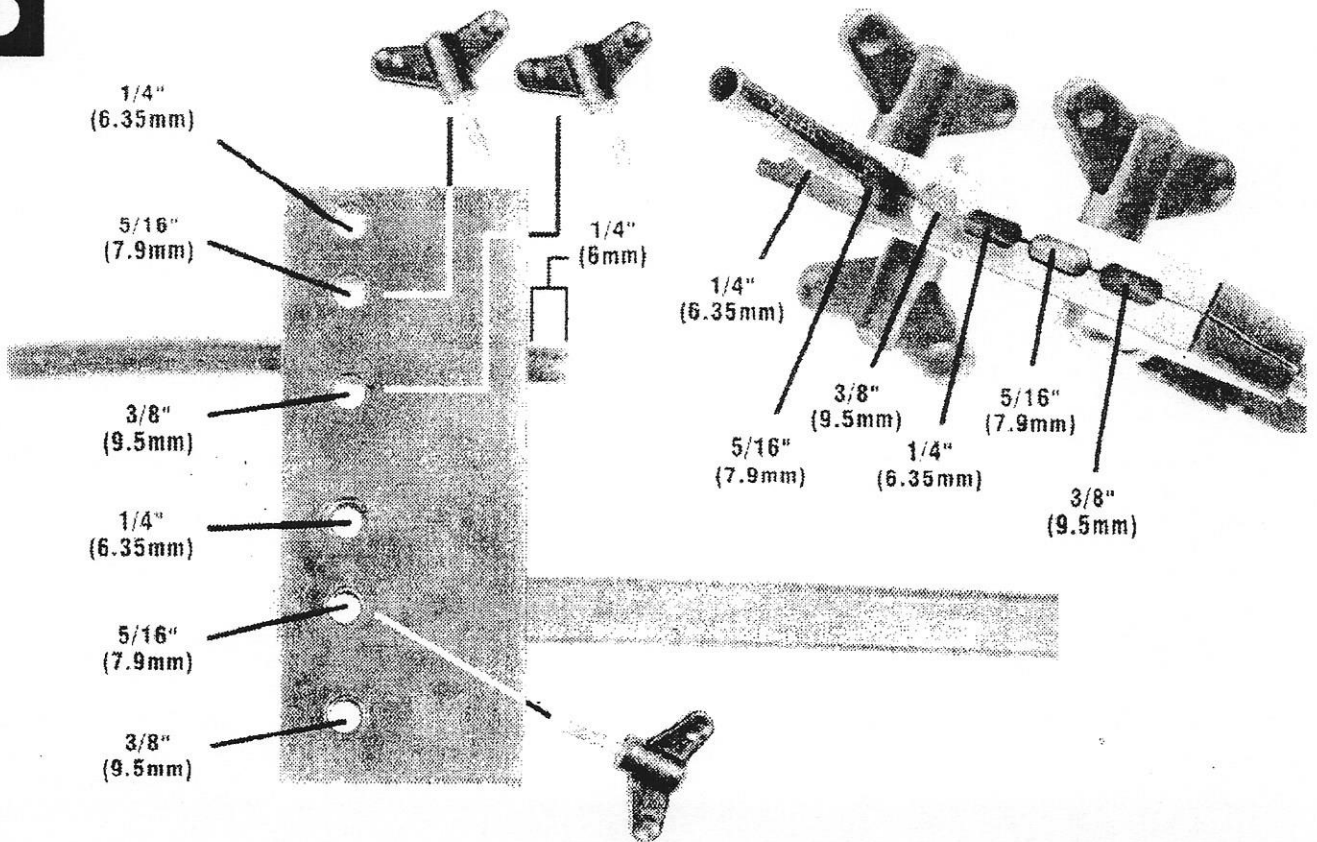

4

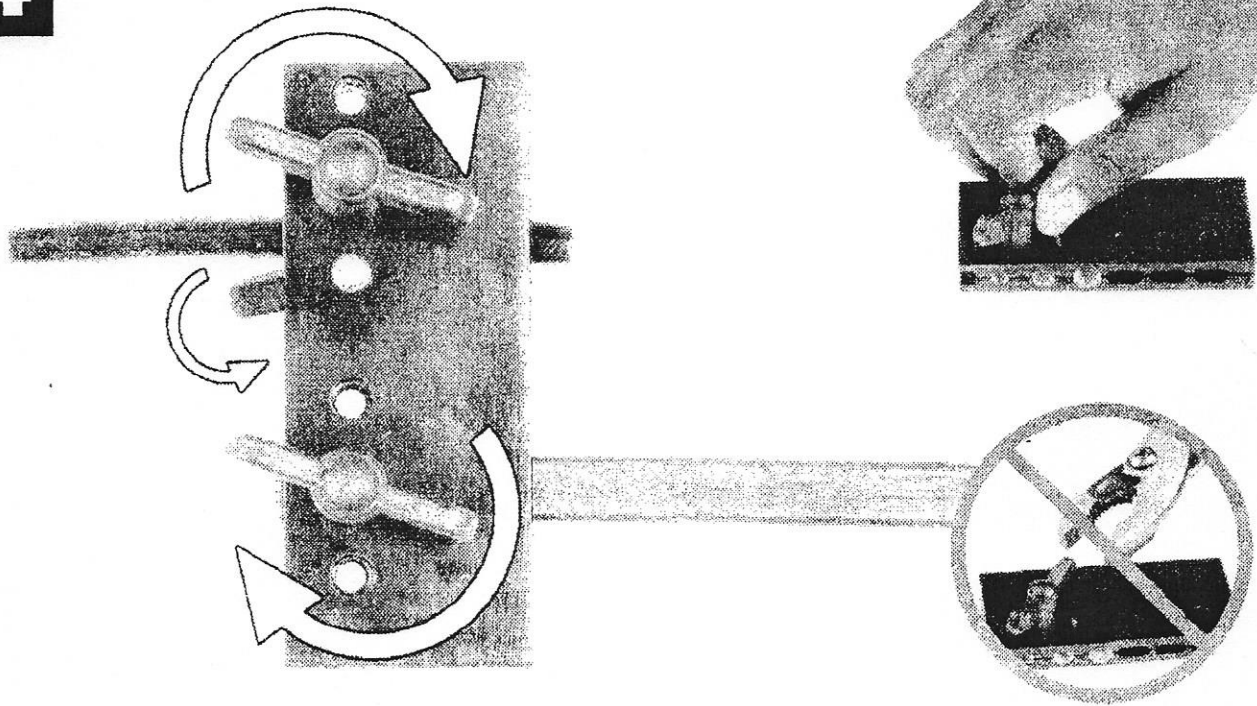

5

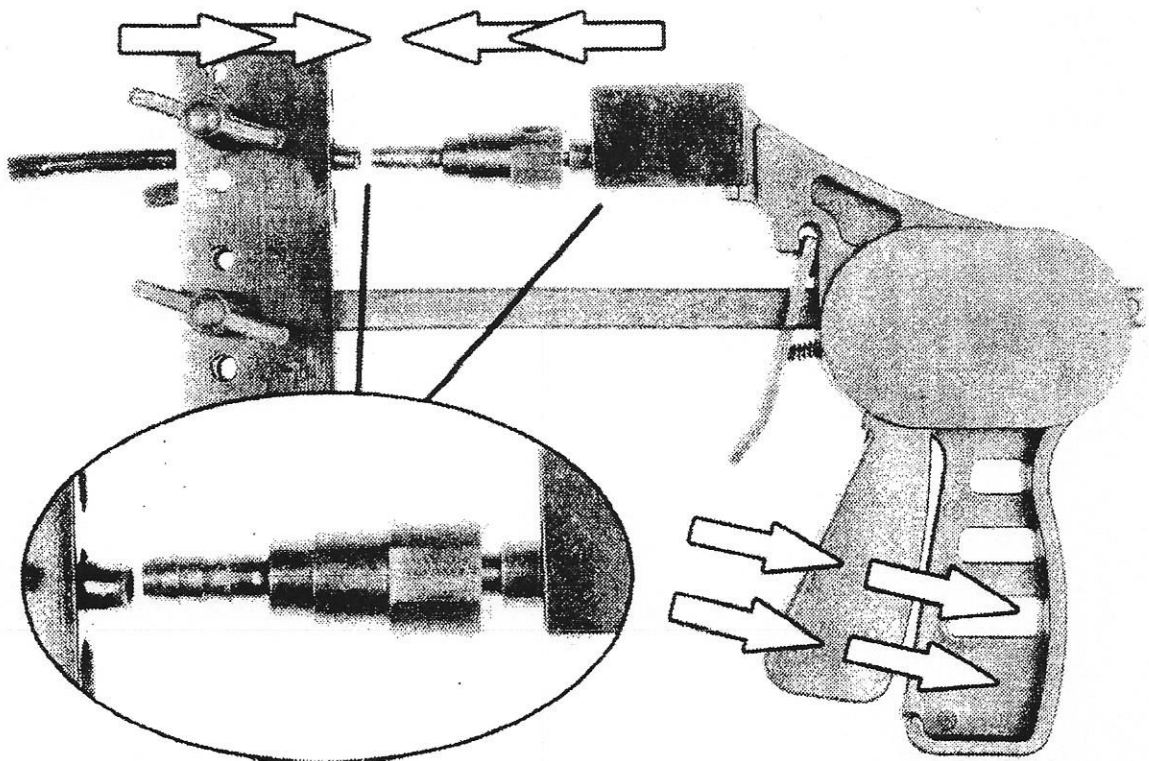

6

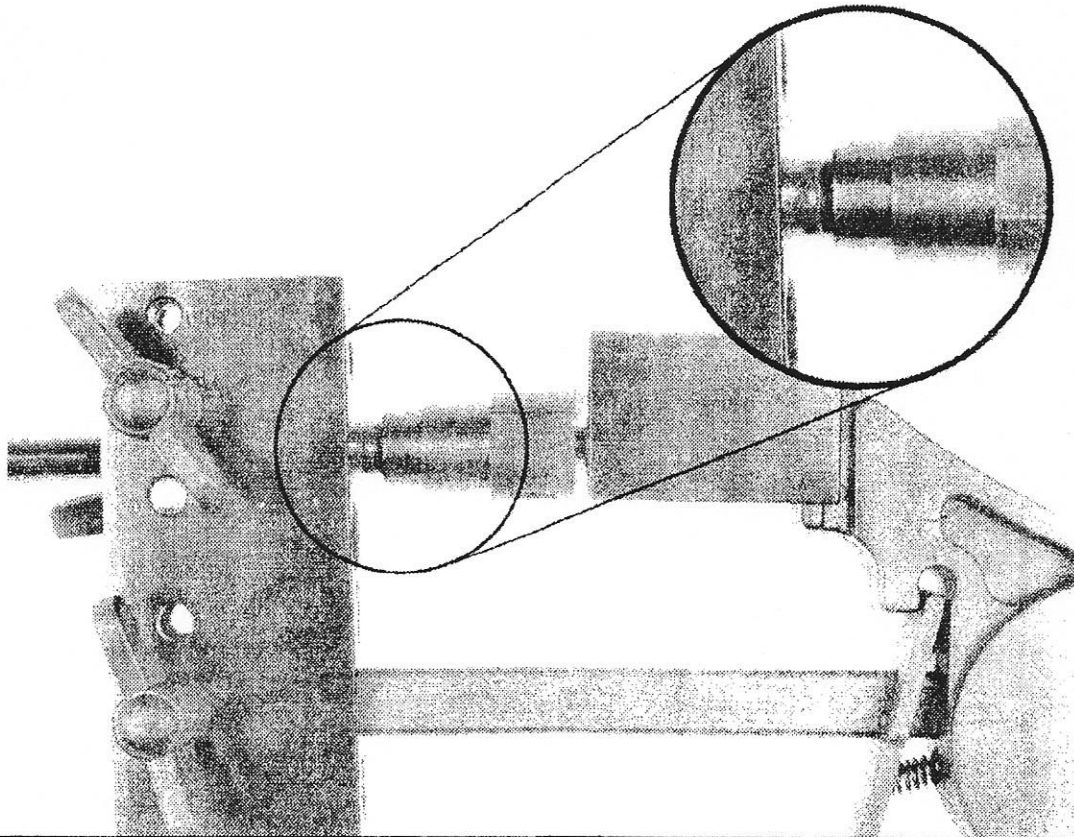

7

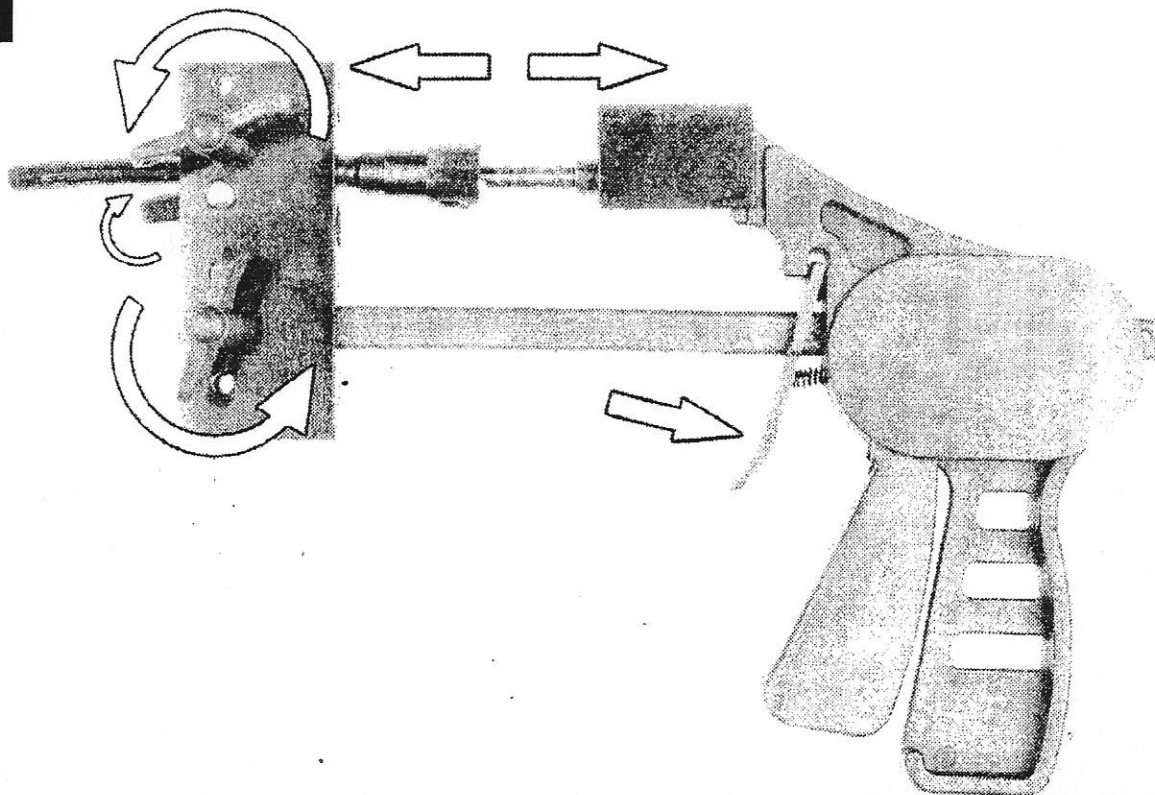

90° Fittings



1

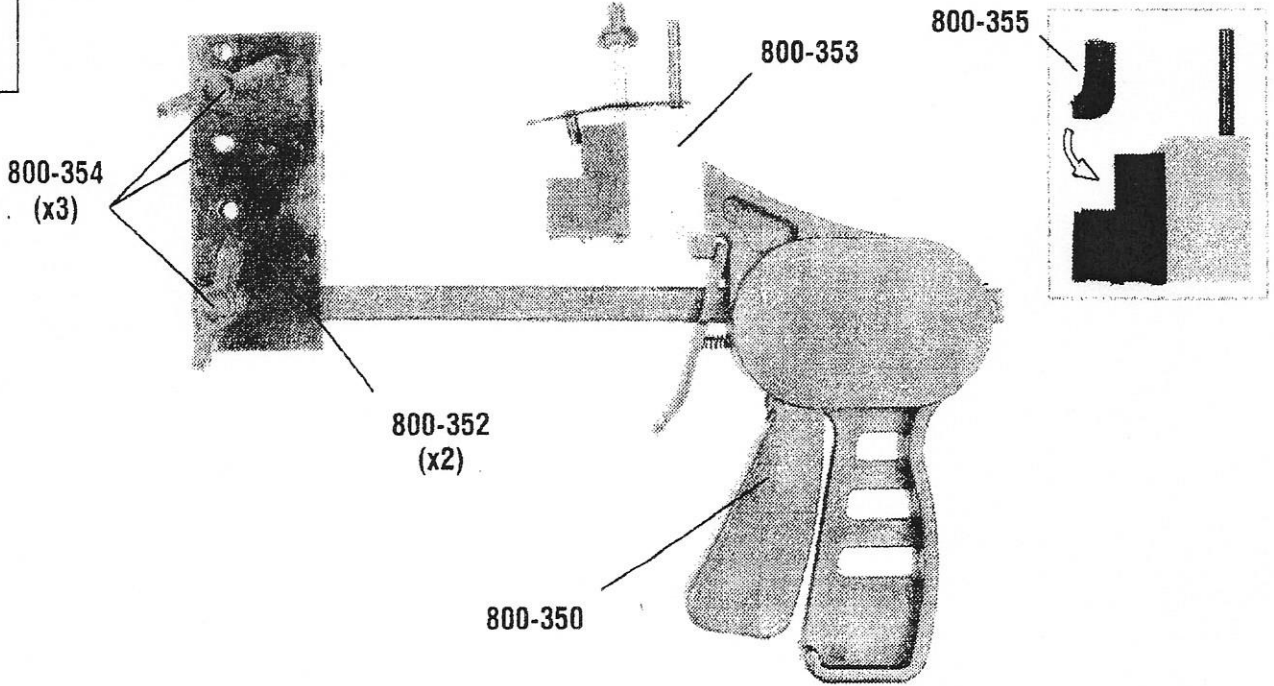

2

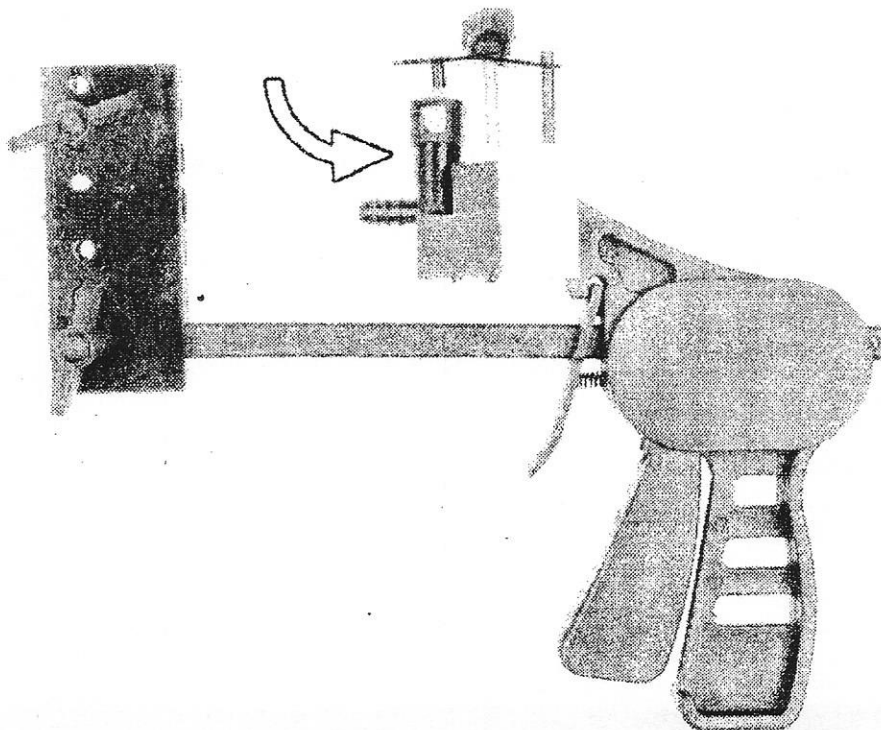

3

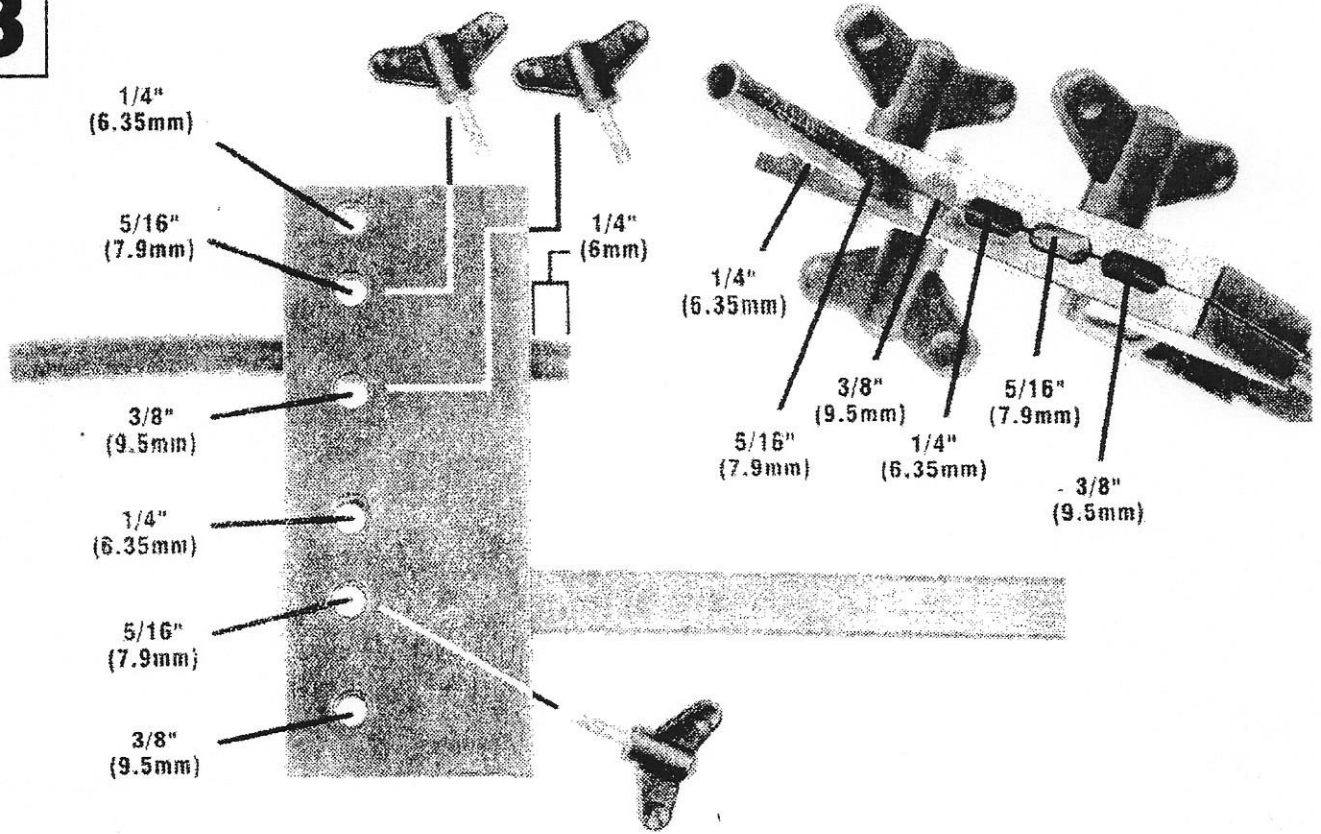

4

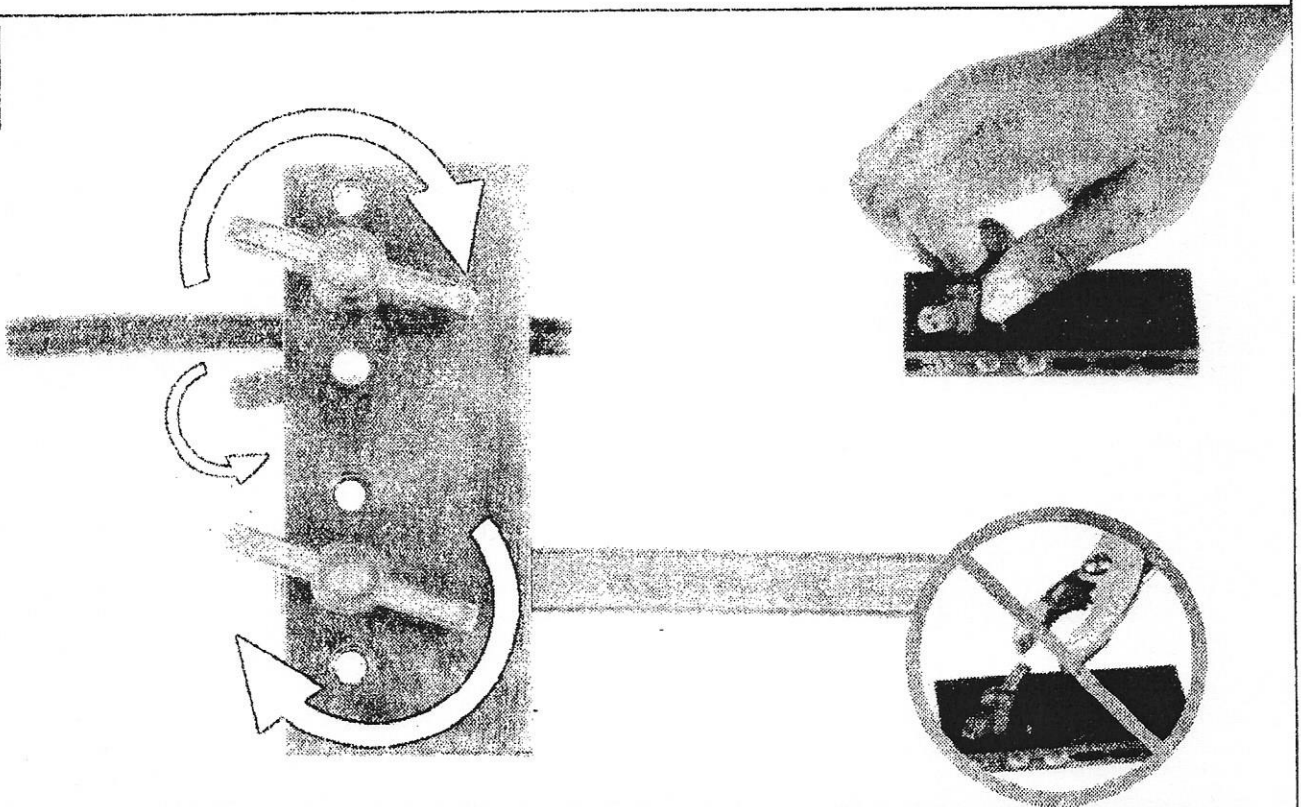

5

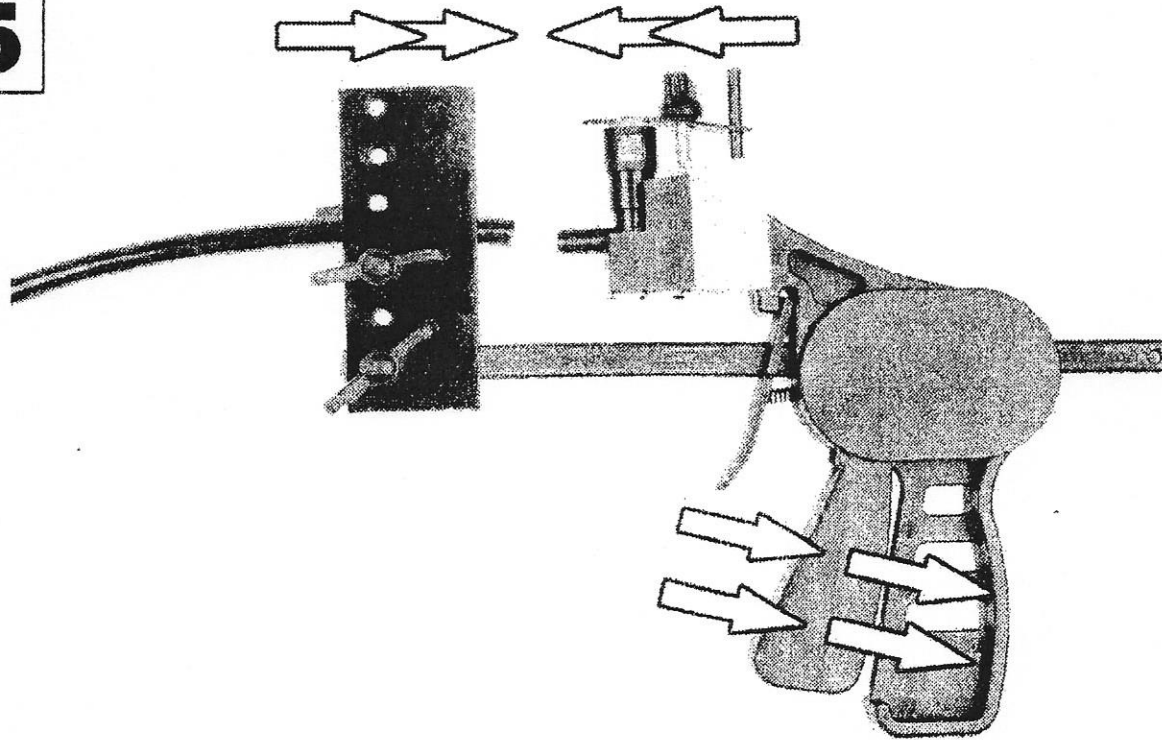

6

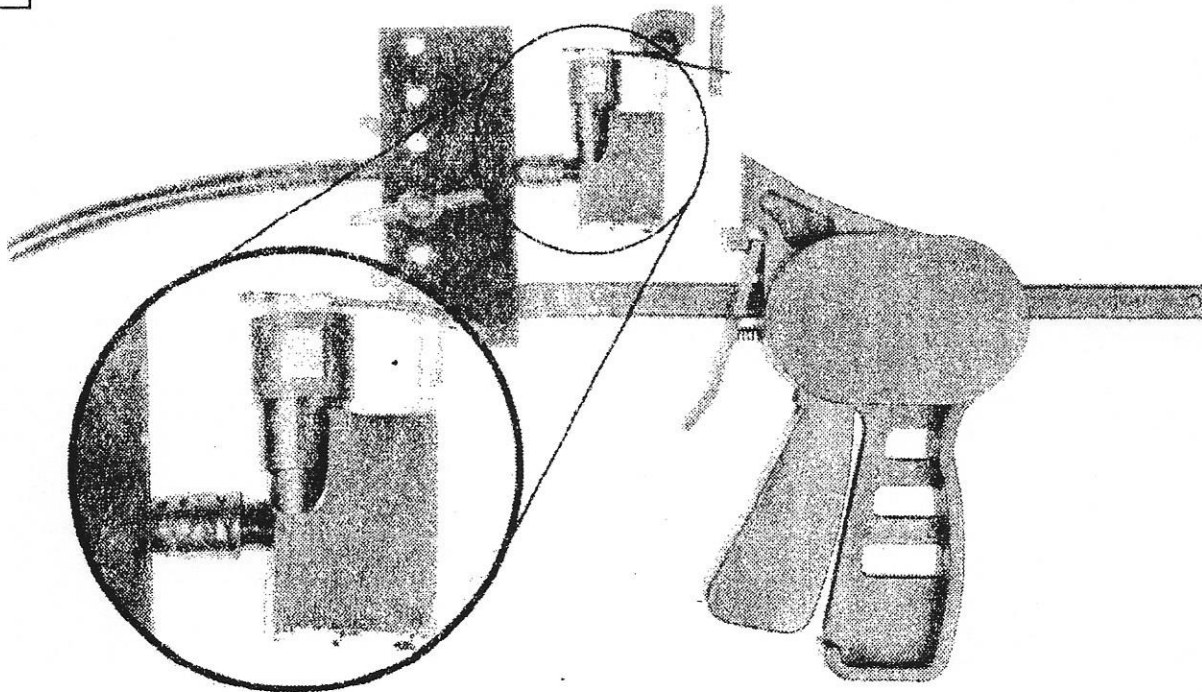

7

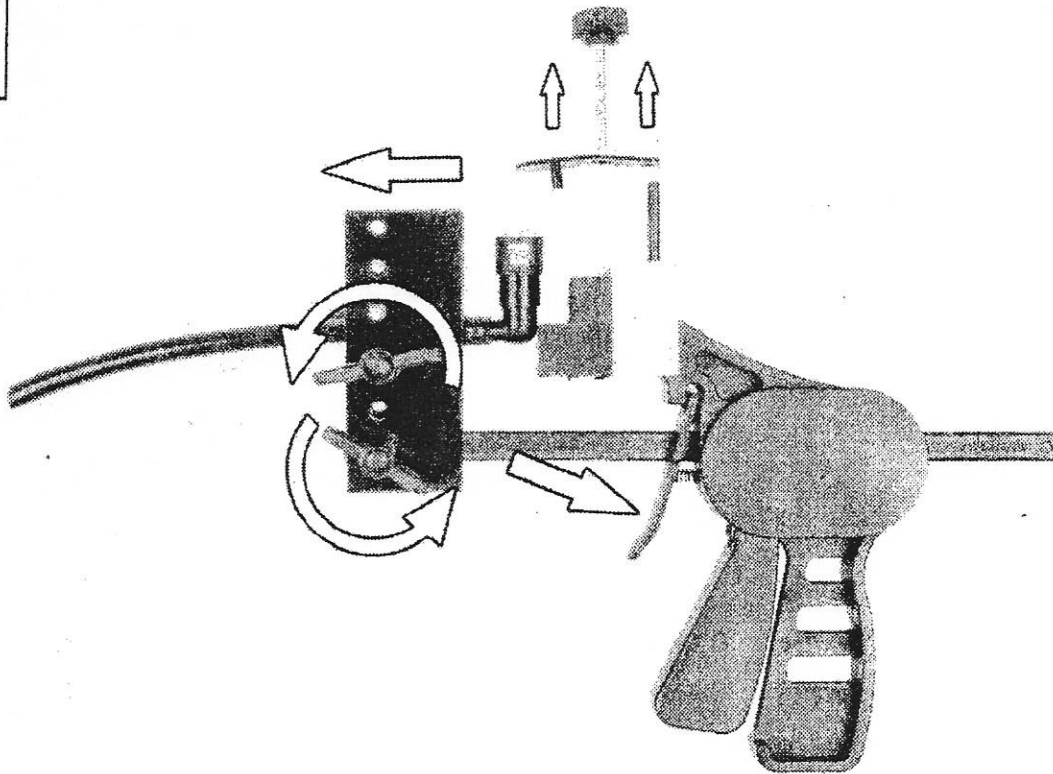

**Barbed
Unions**



1

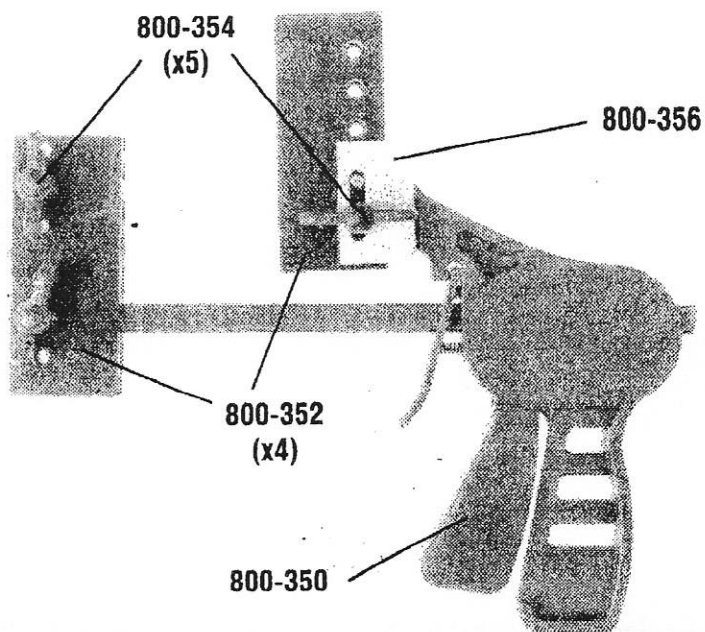

2

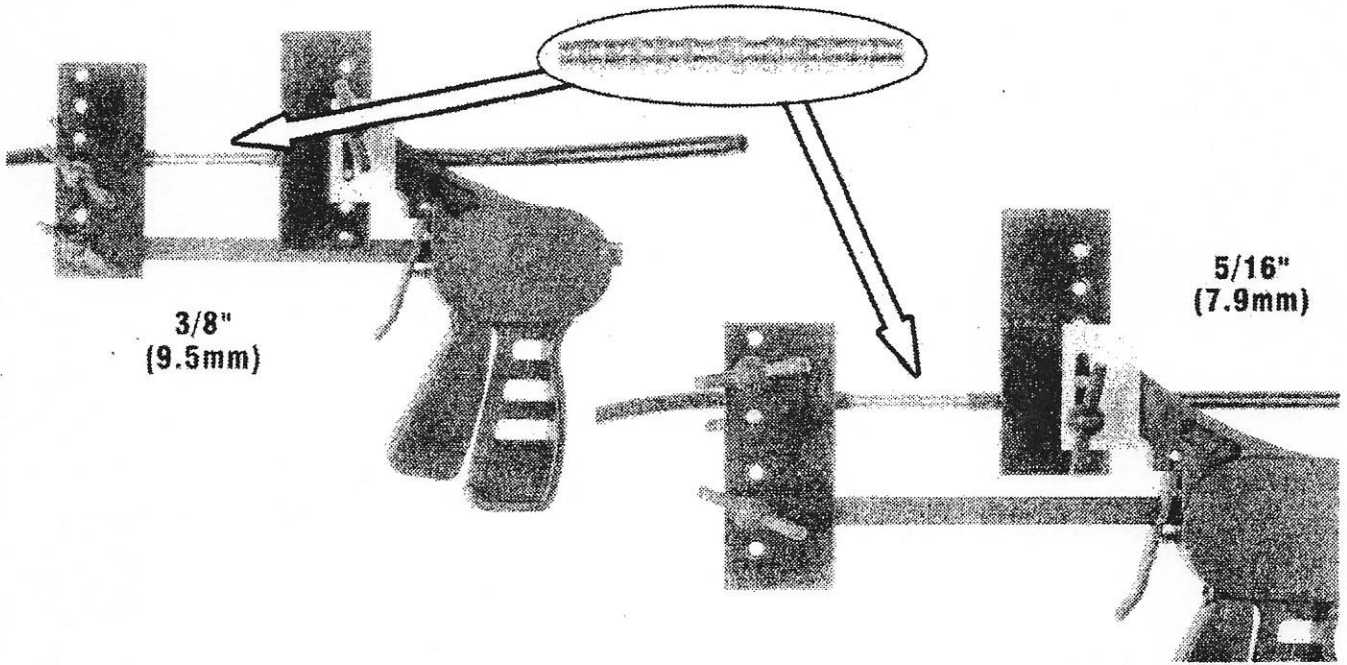

3

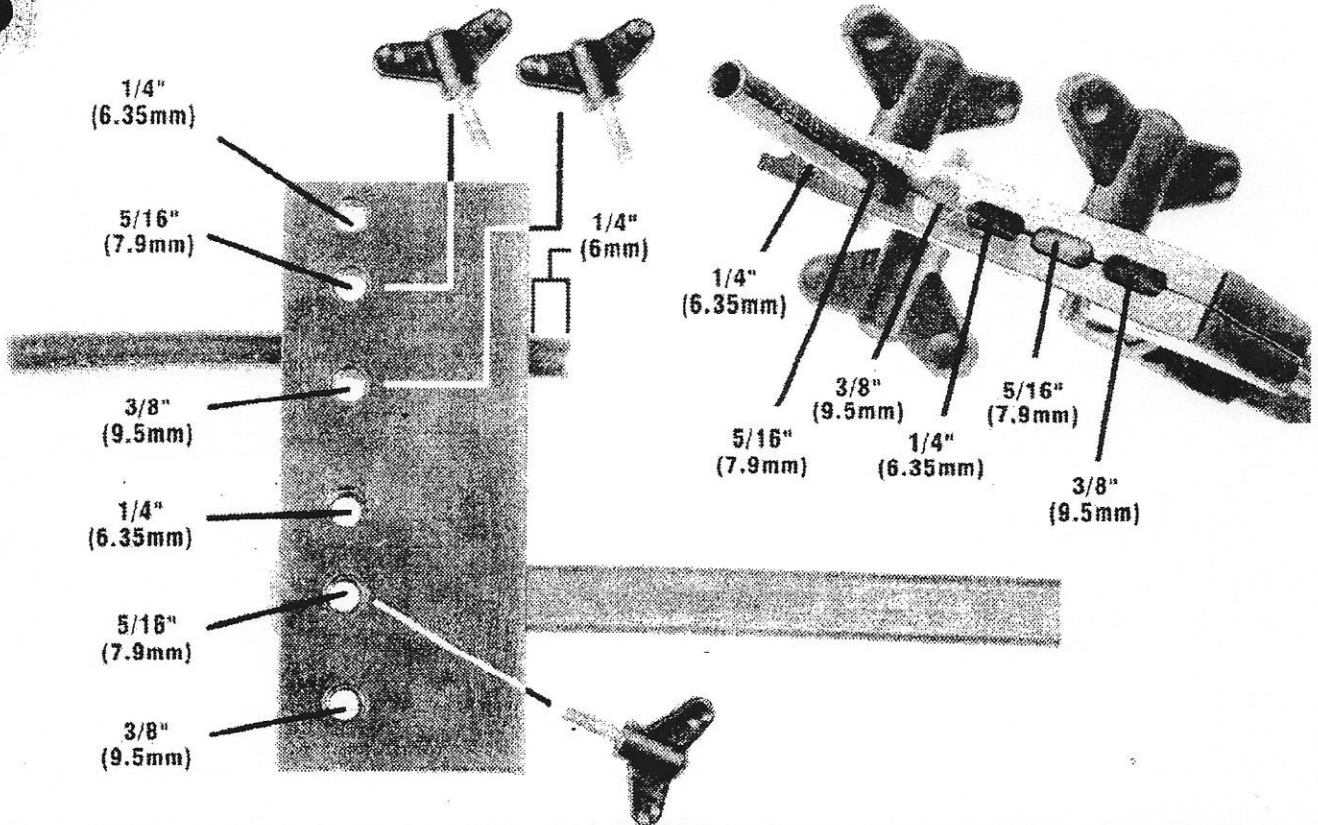

4

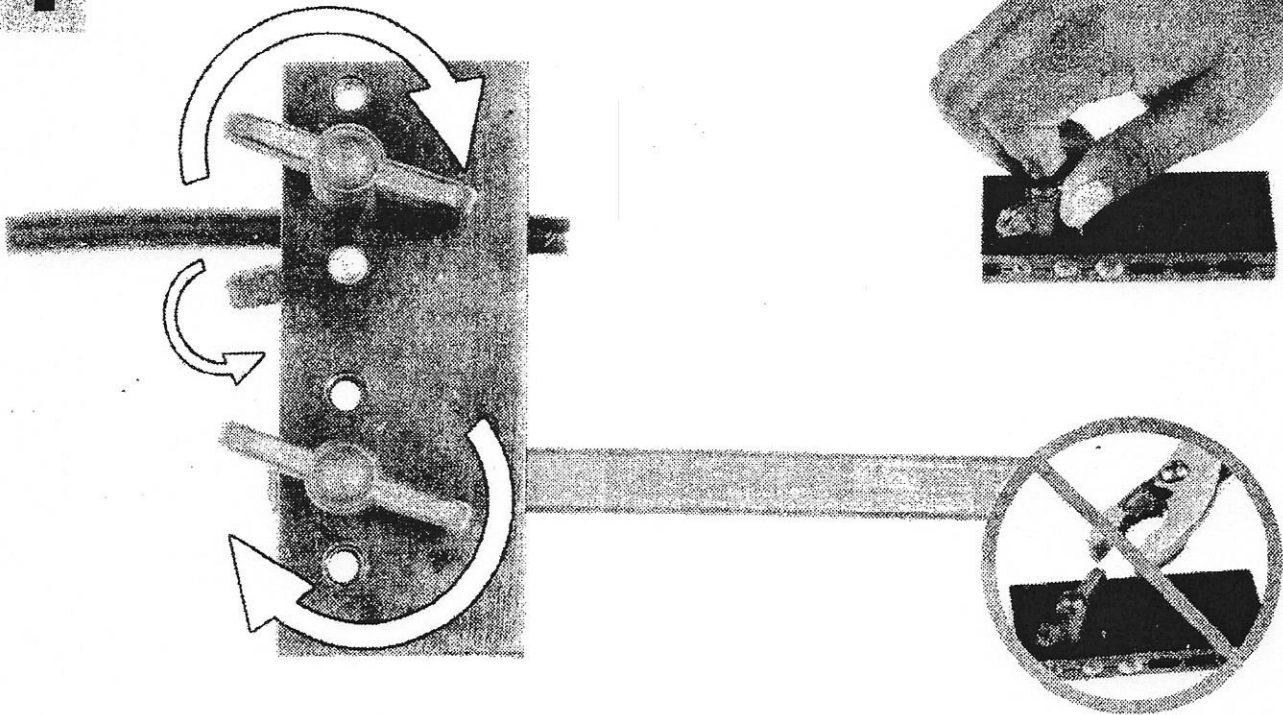

5

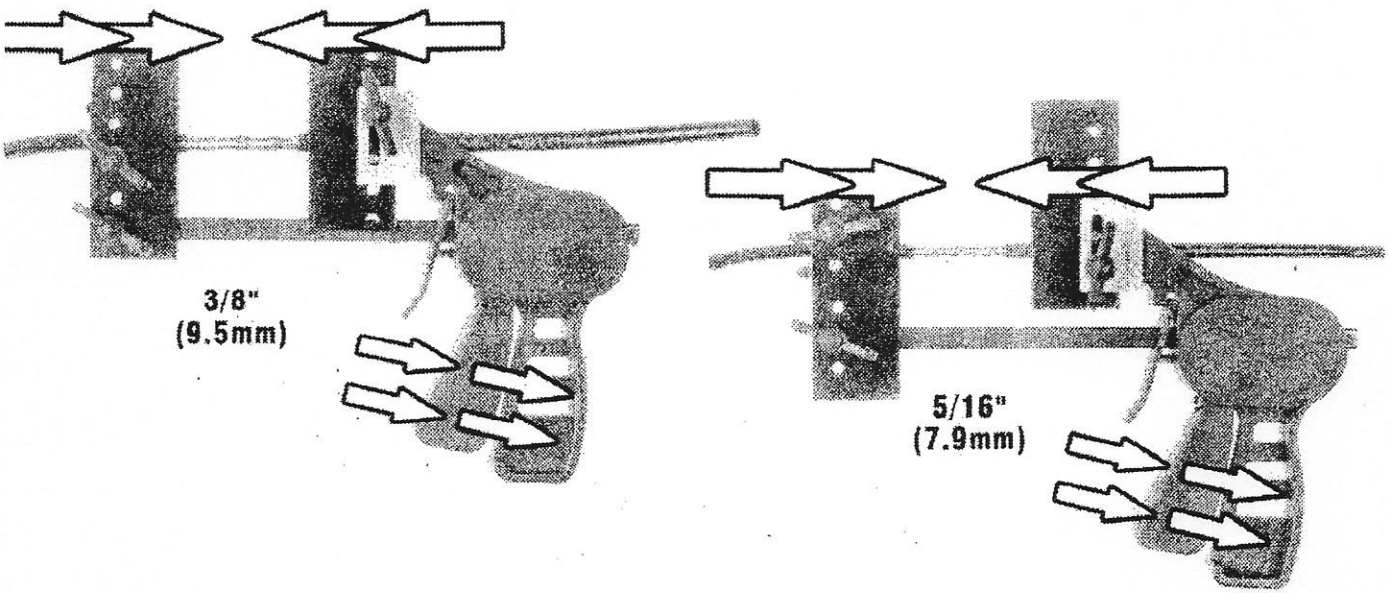

6

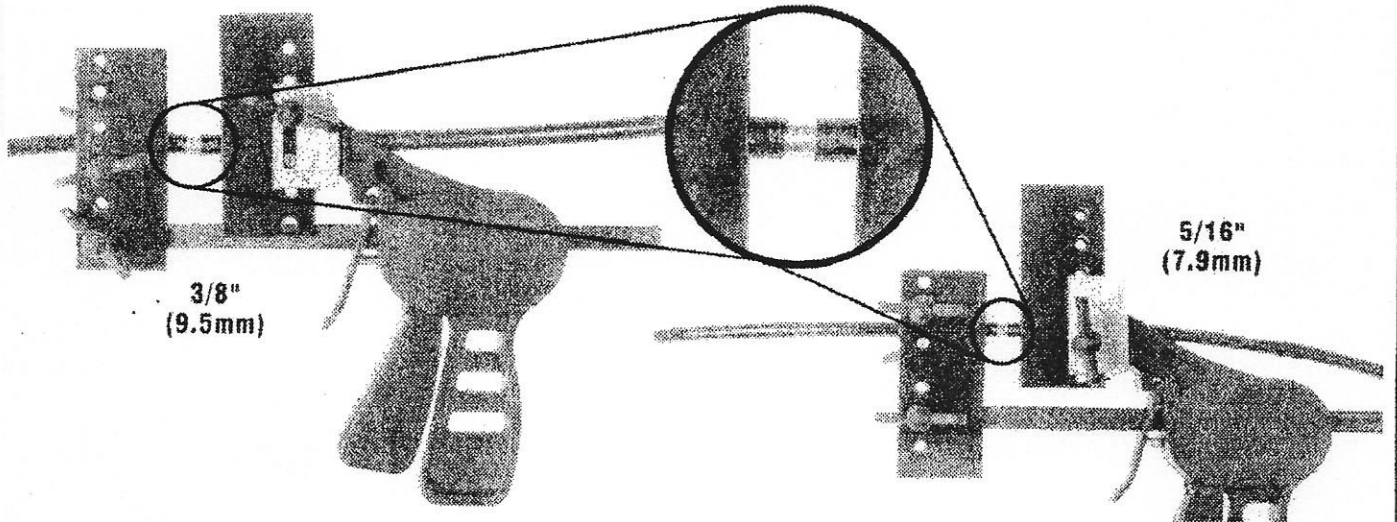

7

